



Jacuzzi® is a registered trademark of Jacuzzi Inc. ©2017 Jacuzzi Inc. All rights reserved.

Questions?

Call our customer service department at 1-800-288-4002, 9 a.m. - 8 p.m., EST, Monday - Friday.

## Solid Surface Sink Installation Instructions

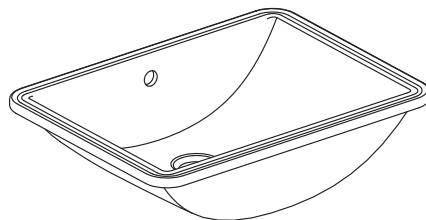

Undermount Sink

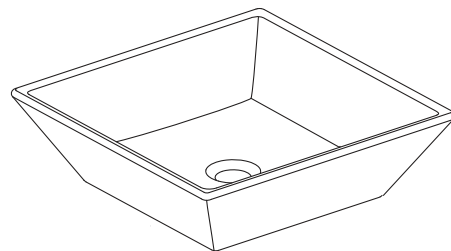

Vessel Sink

### Package Contents

#### Undermount Sink

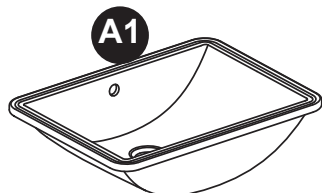

Sink (x1)

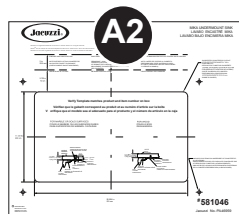

Template (x1)

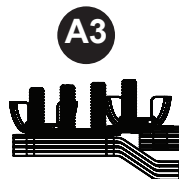

Mounting Brackets (x4)

#### Vessel Sink

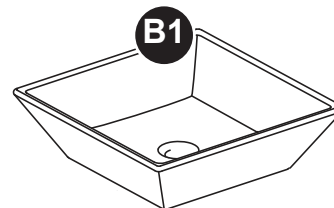

Sink (x1)

### Epoxy Mounting Hardware Contents

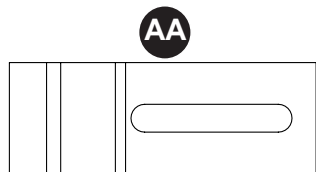

Bracket  
x4 (72x25x2mm)

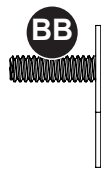

Base  
x4 (Ø6x21x1mm)



Wing nuts  
x4 (Ø6x24x9mm)



Washer  
x4 (OD: Ø7mm)

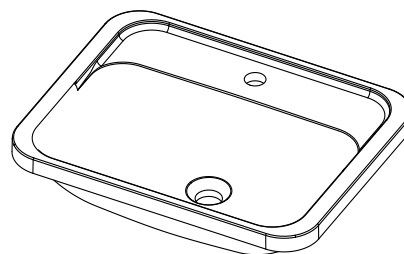

## SAFETY INFORMATION



Please read and understand this entire manual before attempting to install, assemble or operate this product.

### CAUTION

Observe local plumbing and building codes.

These products are designed for installation in or on countertops with a minimum thickness of 1". The installer must supply anchors for thinner countertops.

## Preparation

Before attempting to install this product, make sure all parts are present. Compare parts with package and hardware content lists. If any part is missing or damaged, do not attempt to install, assemble, or operate this product.

**Estimated Assembly Time: 60 minutes.**

### Recommended Tools & Materials



Putty Knife



Adjustable Wrench



Plumbers Putty



Channel Lock Pliers

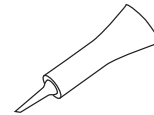

Silicone Adhesive



Tape Measure

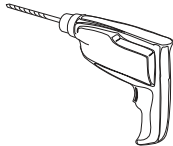

Drill & 3/8" Drill Bit

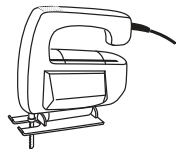

Saber Saw

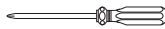

Phillips Screwdriver

*Note: More specialized tools may be necessary to install this sink to countertop materials other than wood or wood composite.*

## Undermount Installation Instructions

### Cut Out Countertop

**IMPORTANT:** All solid surfaces such as marble and granite must be cut by a qualified installer or fabricator.

- 1 Place the provided template in the desired position on the top surface of countertop. This position will be determined by the relationship of the sink rim to the cabinet members and deck mounting fittings.
- 2 Cut out countertop by tracing the edge of the female template with a 3/16" router guide bushing and 1/2" straight cutter bit.
- 3 Finish the cut out edge of the countertop with desired finishing techniques.
- 4 Check cut-out alignment by temporarily placing sink (A1) in the desired mounting position. Refer to Figure A for general assembly image.
- 5 Mount the drain assembly (not included) on the sink, following the faucet manufacturer's instructions. Be certain to apply a bead of sealing putty (not included) on the underside of the drain flange in order to ensure a watertight seal between the sink (A1) and drain. Remove excess putty after installing the drain on the sink (A1). Refer to Figure B general assembly image.

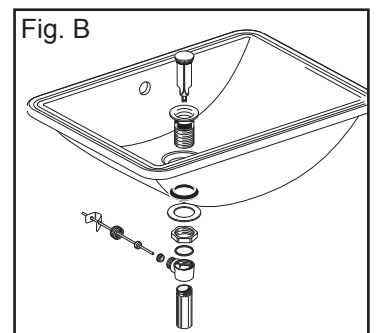
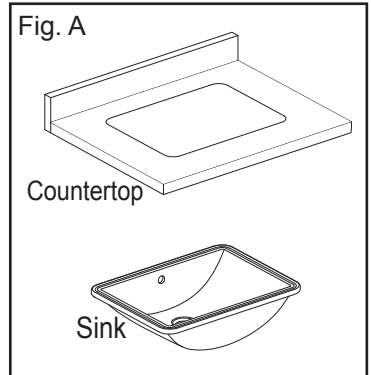

## Undermount Installation Instructions (Continued)

### 6 Epoxy Mounting Brackets

To install the sink using the supplied epoxy base brackets, thoroughly clean the underside of the countertop with alcohol in indicated locations as illustrated (Fig. C). Use a thick epoxy (not included) and apply to the bottom of each perforated bracket base (CC). Press each base bracket firmly into place causing the epoxy to squeeze through the base holes for maximum contact. Allow the epoxy to properly set prior to installing the sink (A1).

Apply adhesive sealant (not included) around the topside rim of sink (A1) near the edge. Carefully raise sink (A1) in place, align and press firmly into place. Wipe off excess sealant. Attach undermount brackets (AA) to hold the sink (A1) in place. Secure each bracket with a washer (DD) and wing nut (BB).

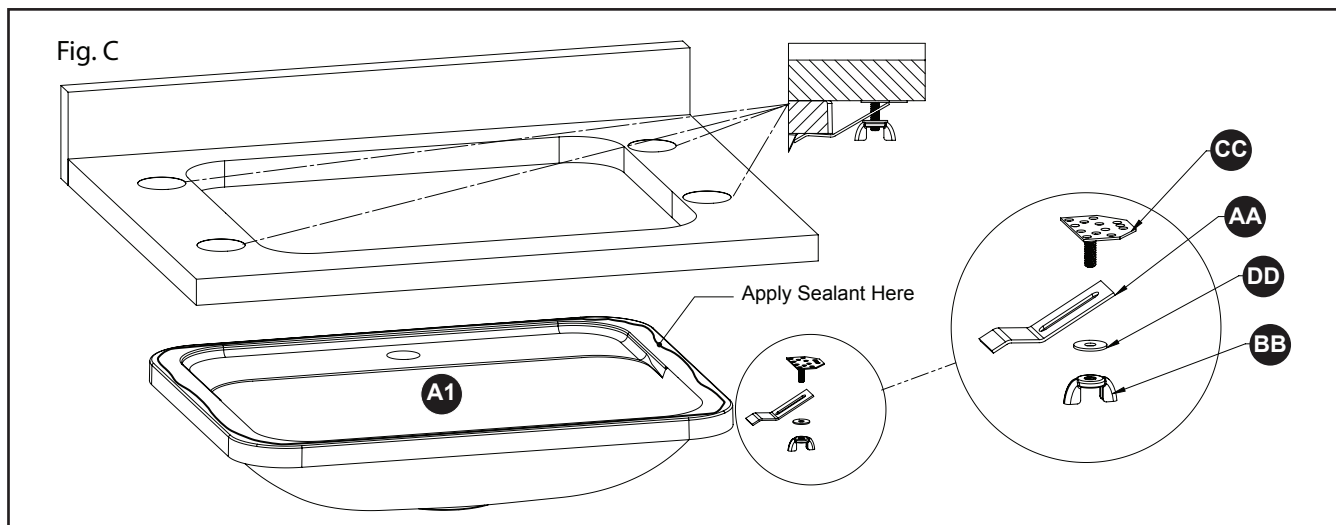

## Vessel Installation Instructions

1 Make sure there is enough space between the backsplash, faucet, fixtures, and cabinets to install the new sink (B1) as illustrated (Fig. D).

2 If a cut out is necessary, trace a 5-1/4" x 5-1/4" square or diameter on the top countertop surface. Make sure the rough-in dimension is 10-1/4" as illustrated (Fig. E). Finally, drill a 1/4" to 1/2" clearance hole near the center of the trace.

3 Following the perimeter line made in step 2, cut out the opening for the sink (B1) into the countertop as illustrated (Fig. F).

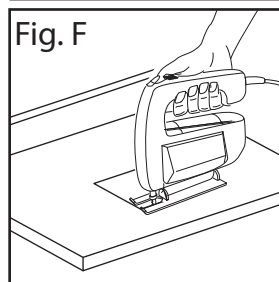
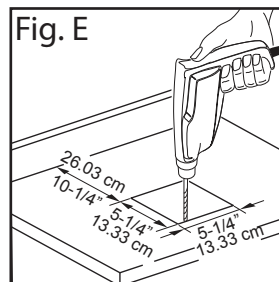
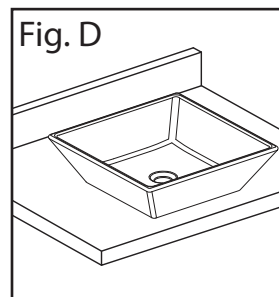

## Vessel Installation Instructions (Continued)

- 4 Check cut-out alignment by temporarily placing the sink (B1) over the desired mounting position as illustrated (Fig. G).

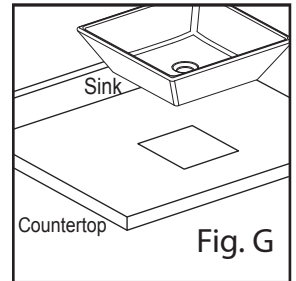

- 5 Apply a bead of sealing putty (not included) on the underside of the drain flange in order to ensure a watertight seal between the sink (B1) and the drain. Remove any excess putty after installing the drain onto the sink (B1). Refer to example (Fig. H).

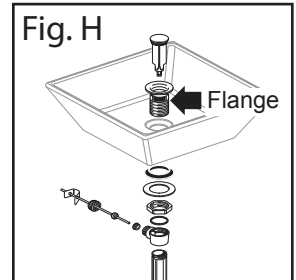

- 6 Once you've checked the fit and alignment, remove sink (B1) and turn upside down as illustrated (Fig. I). Apply a generous amount of sealant (not included) around the underside rim (B1) near the edge as illustrated (Fig. I). Lower the sink (B1) in place, aligning with marks made earlier, and press down firmly. Allow sealant to set before connecting supplies and drain (not included).

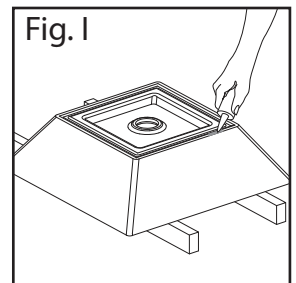

- 7 Install faucet (not included) and countertop (not included) following manufacturers' instructions. Refer to example (Fig. J).

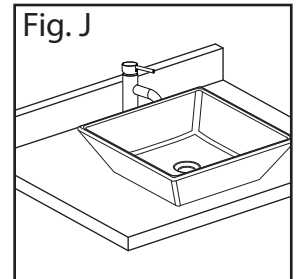

- 8 Connect supply lines and supply shutoff valves per the manufacturers' instructions. Hand tighten all connections for a secure seal. Refer to example (Fig. K).

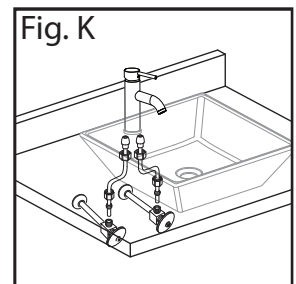

- 10 Connect a trap (not included) to the drain assembly as illustrated (Fig. L). Hand tighten to secure. *Note: It may be necessary to cut off part of the tailpiece of the trap or part of the horizontal leg. Be sure to secure all joints for watertight assembly.*

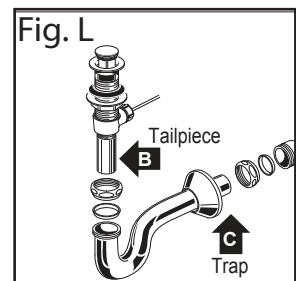

## Care And Maintenance

### Recommendations for Gloss Finish

1. For regular cleaning, a universal cleaning agent with nonabrasive properties, or any mild dish soap and warm water solution can be used.
2. After each use, the inner surface must be rinsed with clean water and wiped dry with a clean cotton cloth.
3. Never use abrasive cleaners for any reason.

**WARNING:** Hair dye, “colored” cosmetics (such as mascara, lipstick, face powder etc.) can create slight discoloration if not removed immediately from the surface of the product.

### Recommendations for Matte Finish

1. For regular cleaning, a universal cleaning agent with nonabrasive properties, or any mild dish soap and warm water solution can be used.
2. After each use, the inner surface must be rinsed with clean water and wiped dry with a clean cotton cloth.
3. Stubborn dirt or stains must be treated with warm water, a gentle cleaning agent, or a mild dish soap solution.

**WARNING:** Hair dye, “colored” cosmetics (such as mascara, lipstick, face powder etc.) can create slight discoloration if not removed immediately from the surface of the product.

## Limited Warranty on Jacuzzi® Luxecast® Sinks

### WARRANTY COVERAGE

Jacuzzi Luxury Bath (“Company”) offers a ninety (90) day non-transferrable limited warranty to the original purchaser (“user”) of a Jacuzzi® Luxecast® sink (“Sink”), for personal or single family residential use, subject to the following terms, conditions and limitations. The Company will repair or replace, at its sole option, the Sink in accordance with the terms, conditions and limitations set forth in this limited warranty. Units in commercial use are excluded from any warranty coverage whatsoever. PLEASE READ THIS ENTIRE LIMITED WARRANTY, AS EXCLUSIONS AND CONDITIONS APPLY. The Sink is warranted against defects in material and workmanship. If at any time during the warranty period the Sink fails due to a covered defect, Company will repair the Sink or provide a replacement Sink, free of charge. This warranty does not apply to any display models or to any options or accessories not specifically mentioned herein. This warranty does not cover staining, discoloration and fading, which can occur over time. Warranty coverage begins on the date the unit was originally purchased by the user. The warranty provided by Company does not cover labor, and is a parts only warranty. Defects or damage caused by the use of other than genuine Company parts is not covered by this warranty.

This limited warranty does not cover damage caused by installation, neglect, misuse, abuse, improper cleaning, the unit’s prior usage as an operational display, defects that should have been discovered before installation, or failure to follow the instructions and warnings set forth in the owner’s/installation manual, including but not limited to cleaning of the Sink and its component parts, such as using chemicals, abrasives, acids, solvents, etc. Inspecting the unit prior to installation is the responsibility of the user, as well as the installer or building contractor who acts on behalf of the user. In the event of a problem, the unit must not be installed. The Company is not responsible for failures or damage that could have been discovered, repaired, or avoided by proper inspection and testing prior to installation. Damage occurring in transit is the responsibility of the carrier. Damage occurring to the unit during installation is the responsibility of the installer, building contractor and/or user, and damage occurring thereafter is the responsibility of the user. The distributor, dealer and user are responsible for knowing local code requirements and notifying the installing contractor of these requirements at the time of purchase. The Company is not responsible for costs to modify any product to obtain any code approval, such as city, county, or state building codes in U.S.A. or federal, municipal, provincial or other codes in Canada and Mexico.

IMPLIED WARRANTIES OF MERCHANTABILITY AND FITNESS FOR A PARTICULAR PURPOSE ARE DISCLAIMED. THIS LIMITED WARRANTY TAKES THE PLACE OF ALL OTHER WARRANTIES, EXPRESS OR IMPLIED, IN FACT OR AT LAW, INCLUDING IMPLIED WARRANTIES OF MERCHANTABILITY AND FITNESS FOR A PARTICULAR PURPOSE. Company reserves the right to use replacement Sink or parts that may be different from the part(s) that accompanied the original Sink, including but not limited to different in appearance, configuration, performance and/or structure. No agent, dealer, distributor, service company or other party is authorized to change, modify or extend the terms of this limited warranty in any manner whatsoever. In addition, THE COMPANY WILL NOT BE RESPONSIBLE FOR INCIDENTAL OR CONSEQUENTIAL DAMAGES or losses arising from any cause or condition (e.g., loss of use, etc.) including but not limited to its own negligence. This exclusion applies even if Company was advised in advance of the possibility of such damages. This limited warranty does not include labor, transportation, or other costs incurred in the removal and/or reinstallation of the original unit and/or installation of a replacement unit; any costs relating to obtaining access for repair; or loss of use damage, including loss of sales, profit or business advantage of any kind under any circumstances. Sink units are excluded from any warranty coverage if any addition, deletion, or modification of any kind whatsoever has been made to the unit (or to any component). Warranty coverage is provided in the United States of America, Canada and Mexico only. The liability of Company under this limited warranty, if any, shall not exceed the original amount paid for the Sink or product claimed to be defective. These disclaimers shall be equally applicable to any service provided by Company and its designated representatives.

Company will honor a valid warranty claim when the following conditions have been met: the failure is of the nature or type covered by the warranty; the user has informed a Company Warranty Service Department Representative of the nature of the problem during the warranty period; conclusive evidence (e.g., original dated proof of purchase) is provided to Company proving that the failure occurred or was discovered within the warranty period; and, if requested by Company, user sends Company any part or the entire Sink claimed to be defective, freight prepaid. In order to obtain warranty service, contact Jacuzzi Luxury Bath at: [www.jacuzzi.com](http://www.jacuzzi.com) or Warranty Service Department, 14525 Monte Vista Avenue, Chino, California 91710, (800) 288-4002. All replacement parts, equipment, and repairs shall assume the remaining warranty period of the part(s) replaced. The Company’s warranty obligation shall be discharged upon tender of replacement or repair. The customer’s refusal to accept the tender terminates the Company’s warranty obligation.

**LEGAL RIGHTS:** This Limited Warranty gives you specific legal rights. There are no warranties applicable to Jacuzzi® products except as expressly stated herein or as implied by applicable state and federal laws. You may also have other rights that vary from state to state. Some states do not allow limitations on how long an implied warranty lasts, disclaimer of certain warranties, or the exclusion or limitation of incidental damages, so some of the above limitations may not apply to you. Company will not be responsible for any statements or representations made in any form that go beyond, are broader than or are inconsistent with any authorized literature or specifications furnished by the Company.



Jacuzzi Luxury Bath  
14525 Monte Vista Avenue  
Chino, California 91710



# WARRANTY REGISTRATION CARD

To complete your registration, visit our website at [www.jacuzzi.com](http://www.jacuzzi.com) or fill out and mail this card to the address printed on the other side within thirty (30) days from date of purchase in order for this warranty to be come effective.



Purchaser's Name \_\_\_\_\_  
 Purchaser's Address \_\_\_\_\_  
 City \_\_\_\_\_ State \_\_ Zip \_\_\_\_\_  
 Home Phone: \_\_\_\_\_ Cell Phone: \_\_\_\_\_  
 Email: \_\_\_\_\_  
 Date of Purchase \_\_\_\_\_  
 Model Name \_\_\_\_\_  
 Serial Number \_\_\_\_\_  
 Dealer's Name \_\_\_\_\_  
 Dealer's Address \_\_\_\_\_

1. How did you first hear about this Jacuzzi product?  
 Advertisement  Article in Magazine/Newspaper  
 Visited Dealer/Plumbing Supplier  Yellow Pages  
 Builder/Plumber/Remodeler  Decorator/Architect  
 Visited Retailer/Home Center Store  
 Word of Mouth . . . Friend/Relative/Acquaintance  
 Other (Please Describe) \_\_\_\_\_
2. Who first gave you specific information about this product (specifications, prices, etc.)?  
 Dealer/Plumbing Supplier  Builder  Remodeler  
 Plumbing Contractor  Retailer/Home Center Store  
 Decorator/Architect  Already Installed
3. What was the main reason for purchase?  
 Styling  Warranty Service  Product Features  
 Brand Name  Price  Hydrotherapy  
 Home Resale \_\_\_\_\_  
 Other \_\_\_\_\_
4. Who finally decided which product you would buy?  
 Self  Spouse  Self and Spouse Together  
 Other Family Member  Designer/Architect  
 Builder/Plumber/Remodeler  Already Installed
5. Who installed?  Already installed/New Home  
 Contractor/Plumber when remodeling  
 Self/Spouse when remodeling  
 Other \_\_\_\_\_
6. What is the current market value of this property?  
 Please estimate \$ \_\_\_\_\_
7. What is the age of the head of the household? Years \_\_\_\_\_
8. What other manufacturers did you consider?  
 Eljer  Lasco  Price Pfister  Aqua Glass  
 Kohler  American Standard  Sterling  
 Other (Specify) \_\_\_\_\_
9. How long did you shop before purchasing unit?  
 1 day  2 months- 6 months  
 2-7 days  6 months- 1 year  
 1 week- 2 weeks  1 year- 2 years  
 2 weeks- 4 weeks  +2 years  
 1 month- 2 months
10. Approximately how long have you lived in this home \_\_\_\_\_?
11. Please indicate, approximately, the total annual income of your household.  
 Up to \$24,999  \$50,000 to \$74,999  
 \$25,000 to \$29,999  \$75,000 to \$99,999  
 \$30,000 to \$39,999  \$100,000 to \$149,999  
 \$40,000 to \$49,999  \$150,000 and Above
12. Was your purchase process?  
 Very easy  Easy  Difficult  Very Difficult
13. How technically aware were you of the patented Jacuzzi jet system prior to your purchase?  
 Not aware  Somewhat aware  Very aware

Ninety-Day  
 Parts Only  
 Limited Warranty  
 On  
 Accessory(ies)